



FREE 3 YEAR WARRANTY REGISTRATION
3 ANS DE GARANTIE, INSCRIPTION GRATUITE
REGISTRO DE GARANTÍA DE 3 AÑOS GRATIS
KOSTENLOSE REGISTRIERUNG 3 JAHRE GARANTIE

三年免费保固

www.AccessoryPower.com/warranty



Please go here to view this document in English:
Pour consulter le document en français, aller sur le lien suivant:
Por favor vaya aquí para ver este documento en Español:
Sie können sich das Dokument hier auf deutsch ansehen:
请到这里查看本文件中英文:

www.AccessoryPower.com/userguides



GO
groove

Groove Pal™



Collect the whole family!

Collectionnez toute la famille!

¡Recoja a toda la familia!

Versammeln Sie die ganze Familie!

收集全部Groove Pal speakers 家庭



Groove Pal™
junior



See more exciting products at:
Voir plus de produits passionnants sur:
Para los productos mas fascinantes visitenos:
Weitere interessante Produkte an:
查看更多精彩的产品:

AccessoryPower.com/promo



Groove Pal™
junior

Package contents
L'emballage contient
Contenidos del paquete
Packungsinhalt
包装内容

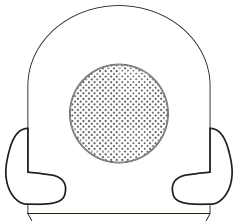

Groove Pal junior
Groove Pal junior
Groove Pal junior
Groove Pal junior
Groove Pal junior



USB power cable
Câble d'alimentation USB
Cable de poder USB
USB Ladekabel
USB电源线

Product diagram
Schéma du produit
Diagrama de product
Produktabbildung
产品图

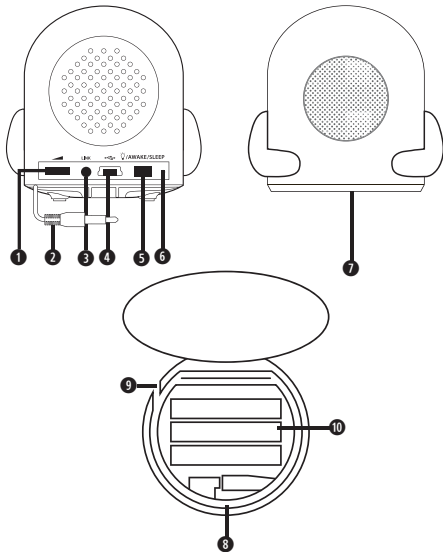

1

Volume control
Contrôle du volume
Control de volumen
Lautstärkenregler
音量控制

2

3.5mm audio cable
Prise jack 3.5mm
Cable de audio 3.5mm
3,5mm Audiokabel
3.5mm音频线





3

3.5mm Pal link
Liaison audio 3.5mm
Enlaces de Pal de 3.5mm
3,5 mm Audio-Anschluss
音频输出连接多个音响

4

USB power port
Port d'alimentation USB
Puerto do poder USB
USB Power Port
USB 充电口

5

 / AWAKE / SLEEP switch
 / AWAKE / SLEEP Interrupteur
 / AWAKE / SLEEP Interruptor
 / AWAKE / SLEEP Schalter
 / AWAKE / SLEEP 开关

6

LED power indicator
Indicateur LED d'alimentation
Indicador LED de alimentación
LED Ladeanzeige
LED电源指示灯

7

LED base
Base LED
Base de LED
LED Sockel
LED底座

8

Cable channel
Encoche pour câble
Ranura de cable
Kabelröhre
插槽

9

Audio cable slot
Fente pour câble audio
Ranura para cable de audio
Steckplatz fürs Audiokabel
音频电源插槽

10

Battery compartment
Compartment des piles
Compartimiento de batería
Batteriefach
电池盒

Operating instructions

Mode d'emploi

Instrucciones de Operación

Bedienungsanleitung

操作说明

Power by Battery
Alimentation par piles
Alimentación por batería
Strom von der Batterie
电源来自电池

Insert 3x AAA batteries
Insérez 3 Piles AAA
Inserte 3 pilas AAA
Legen Sie 3 AAA Batterien ein
安装3个AAA电池

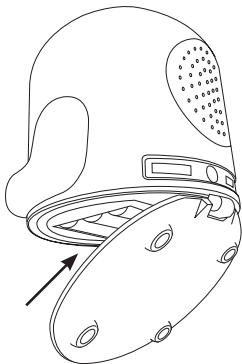

Note: Replace batteries when audio stops. The speaker LED lights may remain on

Note : Remplacer les piles lorsque le son s'arrête. Les LED du haut-parleur peuvent continuer de fonctionner

Nota: Reemplace las baterías cuando se detiene el audio. Las luces LED de altavoz pueden quedar en

Hinweis: Wechseln Sie die Batterie, wenn die Wiedergabe stoppt. Jedoch können ggf. die Lautsprecher LEDs weiter leuchten

注：更换电池时请关闭电源。LED灯可能会亮

Power by USB

Alimentation par USB

Alimentación por USB

Strom von der USB

电源来自USB

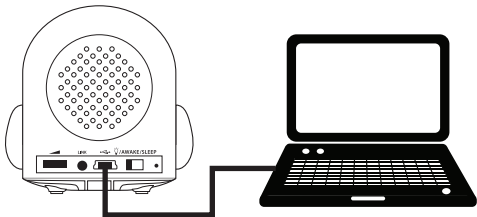

Connect the USB power cable

Branchez le câble d'alimentation USB

Conecte el cable a el puerto de USB

Verbinden Sie das USB-Stromkabel

连接USB充电线

Audio cable management
Gestion du câble audio
Organización del cable de audio
Verwendung des Audiokabels
音频电线

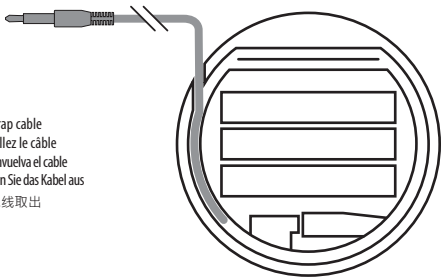

Unwrap cable
Déballez le câble
Desenvuelva el cable
Packen Sie das Kabel aus
将电线取出

Open the LED base, unwrap the 3.5mm audio cable, and guide it through the audio cable slot
Ouvrez la base des LED, déroulez le câble audio 3.5mm et le passer à travers la fente pour câble audio
Abra la base de LED, desenrolle el cable de audio de 3,5 mm y guía a través de la ranura del cable de audio
Öffnen Sie den LED Sockel, wickeln Sie das 3,5mm Kabel ab und ziehen Sie es durch den Audiokabel Steckplatz
打開LED底座和松开3.5mm音频线



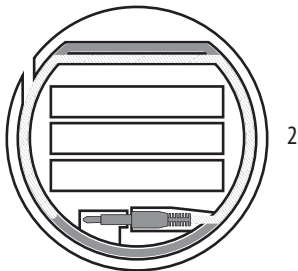
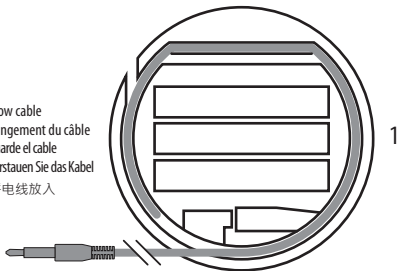

Stow cable
Rangement du câble
Guarde el cable
Verstauen Sie das Kabel
將電線放入

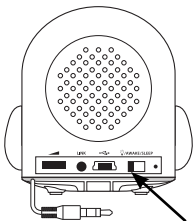

Open the LED base and guide the 3.5mm audio cable through the cable channel
Ouvrez la base des LED, déroulez le câble audio 3.5mm et le passer dans l'encoche pour câble audio
Abra la base de LED y guiar el cable de audio de 3.5 mm a través de la ranura del cable
Öffnen Sie den LED Sockel und ziehen Sie das 3,5mm Audiokabel durch die Kabelröhre
打開LED底座和放入3.5mm音頻線

Playing audio
Lecture audio
Reproducción de audio
Sound abspielen
播放音乐



Use the  / AWAKE / SLEEP switch to power on and control LEDs
Utilisez l'interrupteur  / AWAKE / SLEEP pour le mettre sous tension et contrôler les LED
Utilice el interruptor del  / AWAKE / SLEEP al poder de y LED de control
Mit Hilfe der  / AWAKE / SLEEP Taste steuern Sie die LEDs
使用  / AWAKE / SLEEP 切换电源和LED灯



Connect the 3.5mm audio cable to your device
Branchez le câble audio 3.5mm à votre appareil
Conecte el cable de audio de 3.5 mm a su aparato
Schließen Sie das 3,5mm Audiokabel an
连接3.5mm音频线到您的设备

Connecting additional Groove Pal juniors
Connectez des Groove Pal juniors supplémentaires
Conexión adicional de los Groove Pal juniors
Schließen Sie zusätzliche Groove Pal juniors an
连接其他的Groove Pal juniors

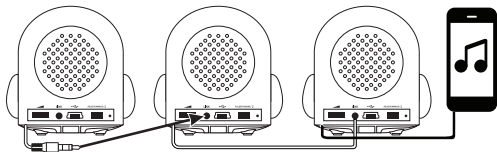

Insert the 3.5mm audio cable into the Pal Link for each additional Groove Pal junior
Insérez le câble audio 3.5mm dans la liaison Pal de chaque Groove Pal junior supplémentaire
Inserte el cable de audio de 3,5 mm en el enlace de Pal para cada Groove Pal junior adicional
Verbinden Sie zusätzliche Groove Pal juniors indem Sie das 3,5mm Audiokabel am Pal Link anschließen
插入3.5mm音频线到连接其他的Groove Pal juniors

Product specifications
Spécifications du produit
Especificaciones del producto
Produktspezifikationen
产品规格

Speaker: 3W; 6W Peak

Audio input: 3.5mm plug

Audio cable length: 14.5 inches

Power input: 3x AAA batteries or USB DC 5V

Battery runtime: Up to 12 hours

Dimensions: 3.6 x 3.5 x 3 inches

Weight: 0.326 pounds

Haut-parleur : 3W; 6W au maximum

Entrée audio : prise jack 3.5 mm

Longueur du câble audio : 60.96 cm

Puissance d'entrée : 3 piles AAA ou USB 5V DC

Autonomie de la batterie : Jusqu'à 12 heures

Dimensions : 9.14 X 8.89 X 7.62 cm

Poids : 164.2 g





www.AccessoryPower.com



[Facebook.com/AccessoryPower](https://www.facebook.com/AccessoryPower)



[Twitter.com/AccessoryPower](https://www.twitter.com/AccessoryPower)



ACCESSORY POWER

©2013 Accessory Power. All rights reserved. Accessory Power, the Accessory Power logo, GOgroove, the GOgroove logo, Groove Pal, the Groove Pal logo, the Groove Pal characters, and other Accessory Power marks and logos are either registered trademarks or trademarks of Bright Ideas, Inc. in the United States and/or other countries. All other trademarks are the property of their respective owners.

Manufactured in China. Designed in California.

© 2013 Accessory Power. Tous droits réservés. Accessory Power, le logo Accessory Power, GOgroove, le logo GOgroove, Groove Pal, les personnages Groove Pal, et les autres marques et logos d'Accessory Power sont soit des marques déposées soit des marques de Bright Ideas, Inc. aux États-Unis et/ou dans d'autres pays. Toutes les autres marques sont la propriété de leurs propriétaires respectifs.

Fabriqué en Chine. Conçu en Californie.

