



## HARNESS STRAP

**FREE 3 YEAR WARRANTY REGISTRATION**  
**3 ANS DE GARANTIE, INSCRIPTION GRATUITE**  
**REGISTRO DE GARANTÍA DE 3 AÑOS GRATIS**  
**KOSTENLOSE REGISTRIERUNG 3 JAHRE GARANTIE**  
**REGISTRATEVI PER UNA GARANZIA GRATUITA DI 3 ANNI**

三年免费保固

[www.AccessoryPower.com/warranty](http://www.AccessoryPower.com/warranty)



Please go here to view this document in English:  
Pour consulter le document en français, aller sur le lien suivant :  
Por favor vaya aquí para ver este documento en Español:  
Sie können sich das hier auf deutsch ansehen:  
Per favore, andate qui per vedere questo documento in inglese:  
请到这里查看本文件中英文:

[www.AccessoryPower.com/userguides](http://www.AccessoryPower.com/userguides)



ReVIVE<sup>®</sup> ReStore<sup>®</sup> Q10x



USA GEAR<sup>®</sup> Q10x

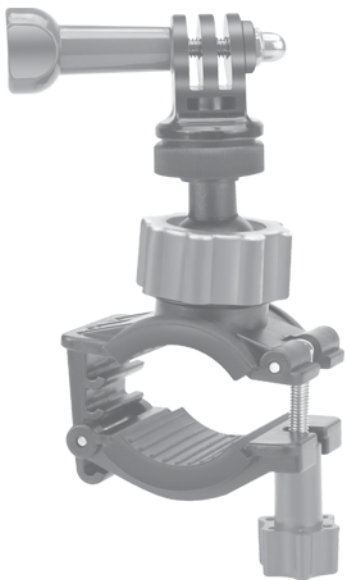

## USA GEAR® Action Mount Series™ Handlebar Mount

See more exciting products at:  
Voir plus de produits passionnants sur :  
Para los productos mas fasinantes visitenos:  
Weitere interessante Produkte an:  
Trovere altri interessanti prodotti presso:  
查看更多精彩的产品:

**[AccessoryPower.com/promo](http://AccessoryPower.com/promo)**

**Product diagram**  
**Schéma du produit**  
**Diagrama de product**  
**Producktabbildung**  
**Schema del prodotto**  
**产品图**

---

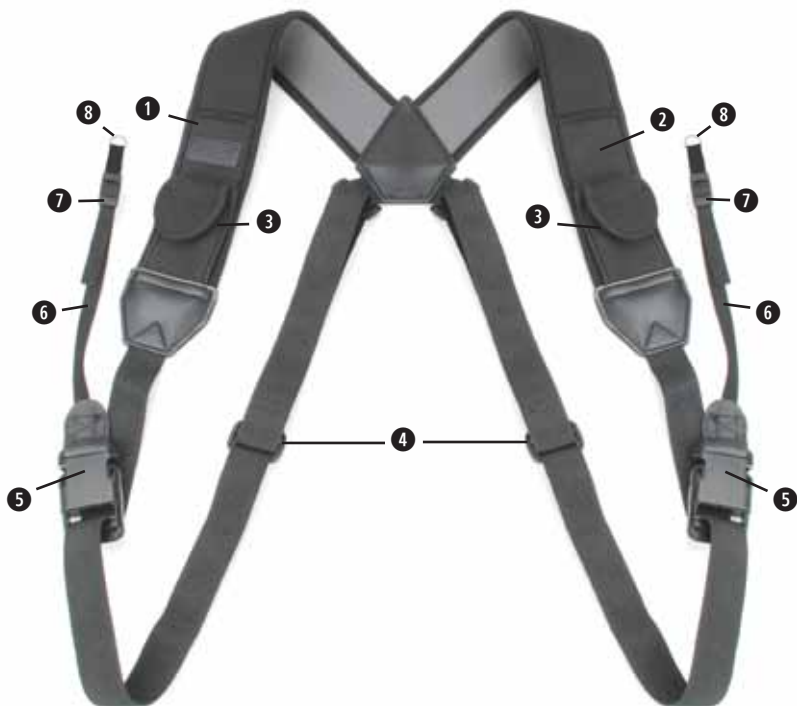

**EN**

- 1 Memory card pocket
- 2 Pen pocket
- 3 Elastic pockets
- 4 Length adjustment buckles
- 5 Quick-release buckles
- 6 3/8 inch webbing
- 7 3/8 inch buckles
- 8 Keyrings

**FR**

- 1 Emplacement pour carte mémoire
- 2 Emplacement pour stylo
- 3 Poches élastiques
- 4 Boucles de réglage de longueur
- 5 Boucles de détachement rapide
- 6 Sangle 9,5 mm
- 7 Boucle 9,5 mm
- 8 Anneau porte clé

**ES**

- 1 Bolsillo para Tarjetas de Memoria
- 2 Bolsillo para Bolígrafo
- 3 Bolsillos Elásticos
- 4 Hebillas de longitud ajustables
- 5 Hebillas de liberación rápida
- 6 Cinta de 9,5 mm
- 7 Hebillas de 9,5 mm
- 8 Llavero

**DE**

- 1 Tasche für Speicherkarten
- 2 Tasche für Stifte
- 3 Elastische Taschen
- 4 Schnallen für die Längenanpassung
- 5 Schnellverschlusschnallen
- 6 9,5 mm Zoll Gurtband
- 7 9,5 mm Zoll Schnallen
- 8 Schlüsselring

**IT**

- 1 Tasca memory card
- 2 Tasca portapenna
- 3 Tasche elastiche
- 4 Fibbie di regolazione lunghezza
- 5 Fibbie ad apertura rapida
- 6 Fettucce da 9,5 mm
- 7 Fibbie da 9,5 mm
- 8 Anelli portachiavi

**ZH**

- 1 存储卡袋
- 2 笔袋
- 3 弹性袋
- 4 长度调整扣
- 5 快速释放扣
- 6 9,5mm 寸织带
- 7 9,5mm 寸扣
- 8 圈扣

## Connect to your camera

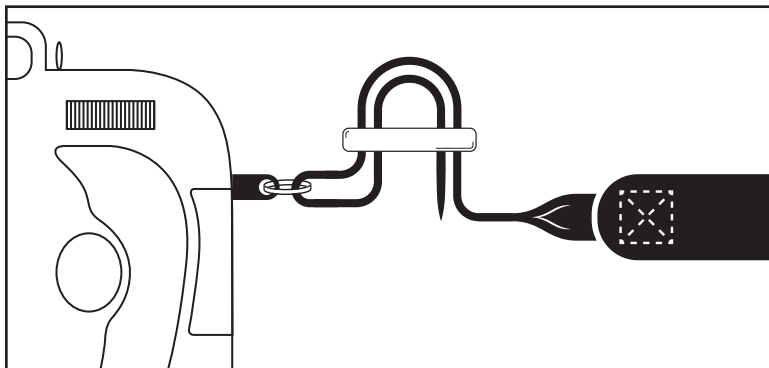
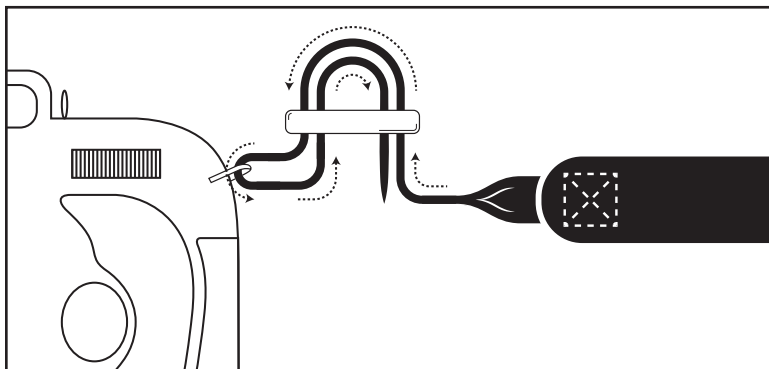

Connect the 3/8 inch webbing to both sides of the camera.  
Use keyrings to attach to cameras without 3/8 inch opening.

## Adjust the strap



Use 3/8 inch buckles and length adjustment buckles to adjust to your desired length.

## Fixer votre appareil photo

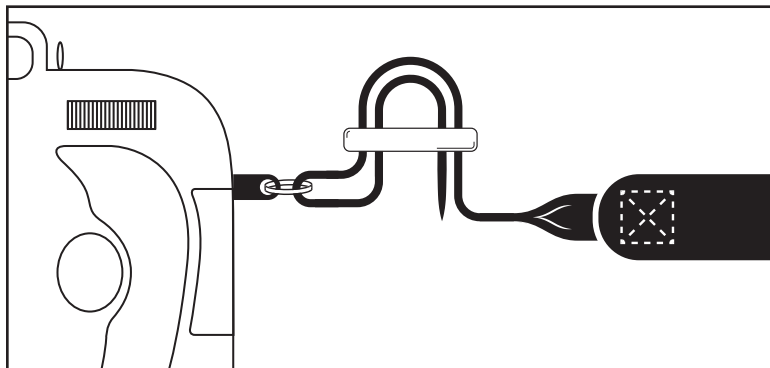
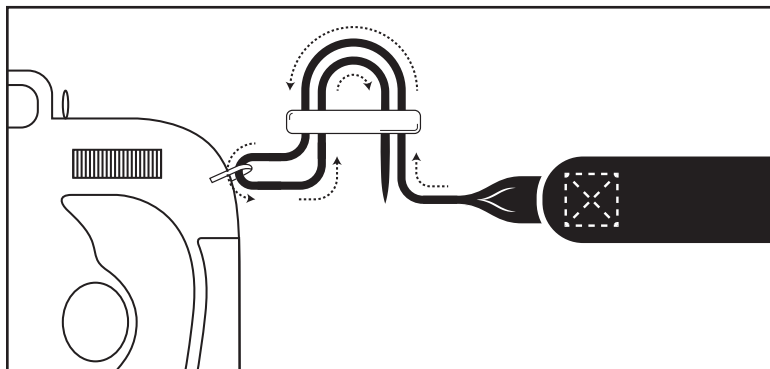

Attacher la sangle 9,5 mm de chaque côté de l'appareil photo.

Utiliser l'anneau porte clé pour fixer les appareils photo sans emplacement pour sangle 9,5 mm.



## Ajuster la sangle



Utiliser les boucles 9,5 mm et les boucles de réglage pour ajuster à la longueur désirée.

## Conectando a su cámara

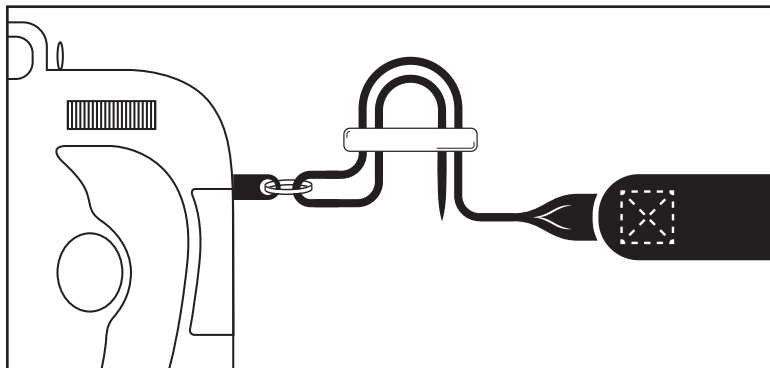
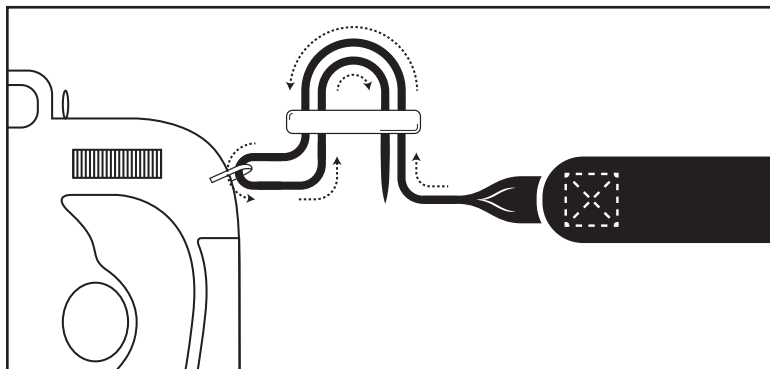

Conecte la cinta de 9,5 mm a ambos lados de su cámara  
Use los llaveros para enganchar a cámaras sin apertura de 9,5 mm.

## Ajuste la Correa



Use las hebillas de 9,5 mm y ajuste la longitud de las hebillas al largo deseado.

## An Ihrer Kamera befestigen

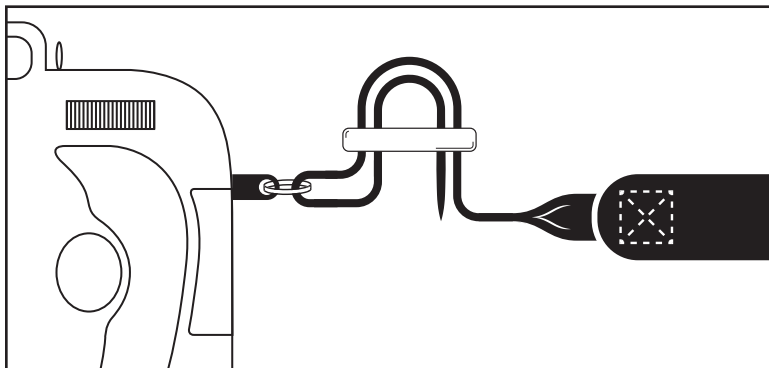
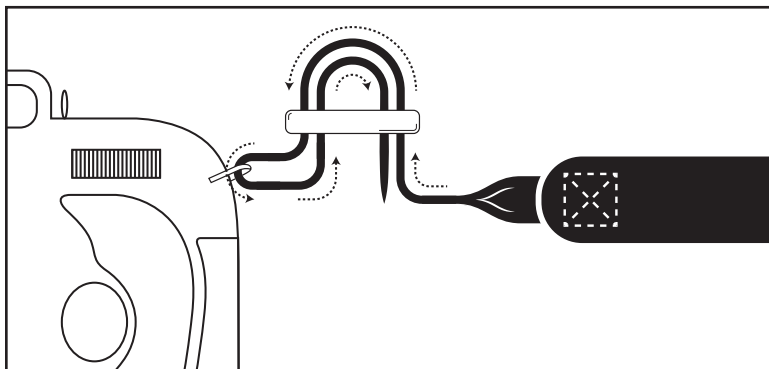

Befestigen Sie das 9,5 mm Zoll Gurtband an beiden Seiten der Kamera.  
Benutzen Sie die Schlüsselringe um Kameras ohne 9,5 mm Zoll Öffnung zu befestigen.

## Länge des Gurtes anpassen



Mit Hilfe der 9,5 mm Zoll Schnallen und der Schnallen zum Anpassen der Länge können Sie die gewünschte Länge einstellen.

## Collegare la fotocamera

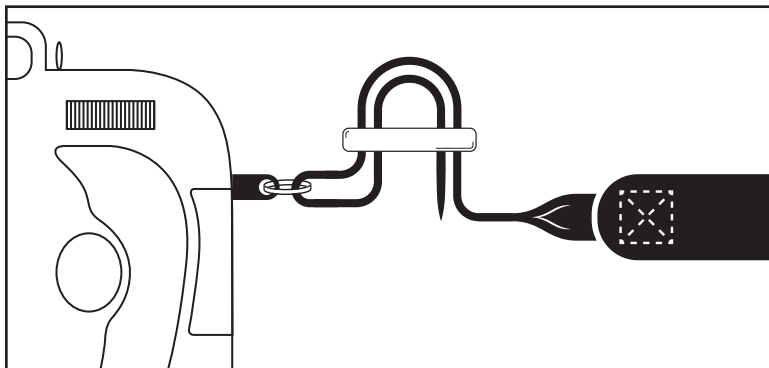
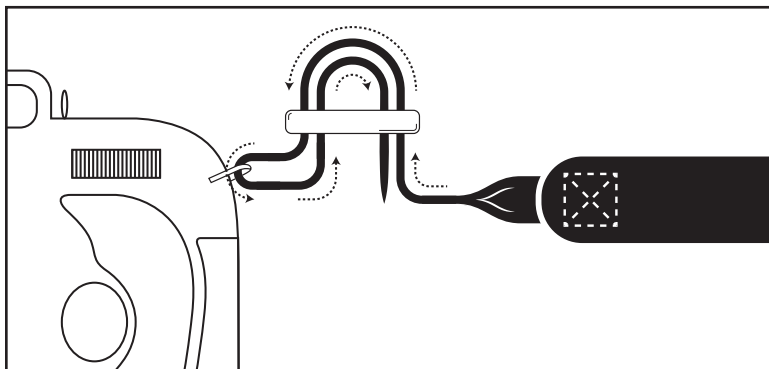

Far passare la fettuccia da 9,5 mm su entrambi i lati della fotocamera.  
Nel caso in cui la fotocamera non disponga di fessure per far passare la fettuccia, utilizzare gli anelli portachiavi.

## Regolare l'imbragatura



Per regolare l'imbragatura alla lunghezza desiderata utilizzare le fibbie di regolazione della lunghezza e quelle da 9,5 mm.

## 连接您的相机

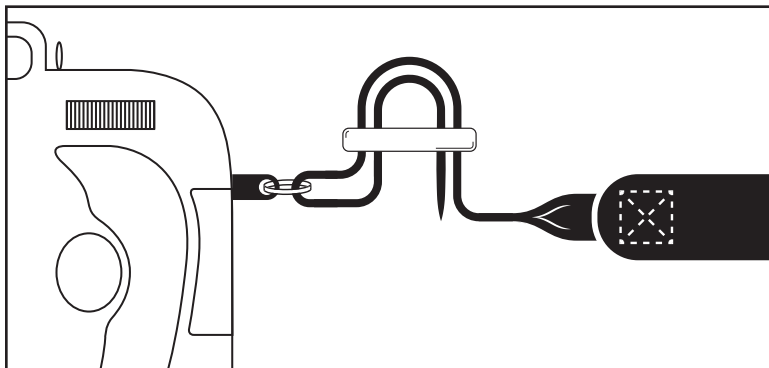
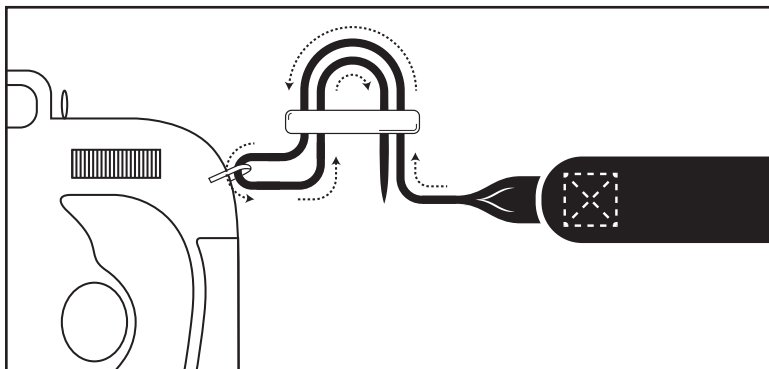

将9,5 mm 寸织带连接相机的两边  
没有9,5 mm寸开口就使用圈扣挂在相机上



## 调整背带



使用9,5 mm寸扣和长度调整扣调整您理想的长度



**Product specifications**  
**Spécifications du produit**  
**Especificaciones del producto**  
**Produktspezifikationen**  
**Specifiche del prodotto**  
**产品规格**

---

Connection: 3/8 inch webbing; keyring  
Length each side: Minimum 56 inches,  
maximum 68 inches  
Weight: 5.12 ounces

Fixation: sangle 9,5 mm; anneau porte-clef  
Longueur de chaque côté: minimum de 1,4 m  
maximum de 1,7 m  
Poids: 145 g



[YouTube.com/AccessoryPower](https://www.youtube.com/AccessoryPower)



[Facebook.com/AccessoryPower](https://www.facebook.com/AccessoryPower)



[Twitter.com/AccessoryPower](https://www.twitter.com/AccessoryPower)

This product comes with a limited warranty, the acceptance of which is a condition of sale.  
For details visit [accessorypower.com/warranty](http://accessorypower.com/warranty).

Ce produit est couvert par une garantie limitée, dont l'acceptation est une condition de vente.  
Pour plus de détails, visitez [accessorypower.com/warranty](http://accessorypower.com/warranty).



**ACCESSORY POWER®**

© 2015 AP Global, Inc. All rights reserved. Accessory Power, the Accessory Power logo, ReVIVE, ReStore, USA GEAR, the USA GEAR logo and other Accessory Power marks and logos are either registered trademarks or trademarks of AP Global, Inc. in the United States and/or other countries. All other trademarks are the property of their respective owners.

**Manufactured in China. Designed in California.**

© 2015 AP Global, Inc. Tous droits réservés. Accessory Power, le logo Accessory Power, ReVIVE, ReStore, USA GEAR, le logo USA GEAR et les autres marques et logos d'Accessory Power sont soit des marques déposées soit des marques de AP Global, Inc. aux et/ou dans d'autres pays. Toutes les autres marques sont la propriété de leurs propriétaires respectifs.

**Fabriqué en Chine. Conçu en Californie.**

**WARNING! THIS PRODUCT IS NOT LIFE SAVING EQUIPMENT.  
AVERTISSEMENT! CE PRODUIT N'EST PAS UN EQUIPEMENT DE SAUVETAGE.**

